

Application



F300 749

PVRE, PVRET and Prof joysticks from Sauer-Danfoss are generally used together with PVGs and PVEs, but can be used in any application. A complete range of joysticks from the simple PVRE handle with X-Y functions to the Prof 1 ergonomic handle with rollers and pushbuttons are available.

Mechanical Design

All handle variants share the same mechanical base to which the electronics are mounted. The mounting flange of the joystick is an integrated part of the mechanical base, which also contains a linkage that transfers handle movement to the electronics. The linkage also includes neutral positioning springs. The neutral positioning springs are designed to ensure a smooth return of the handle into neutral position. The maximum spring force is optimised to be just strong enough to keep the handle in position, even during operation in rough terrain, without interfering with the operation of the joystick or impairing its ergonomic characteristics.

Spring force	8-10 N
--------------	--------

Main Function Module

(Prop1 and Prop2)
 The primary functions of the joystick are defined as its X and Y directions.

Main functions are potentiometers with integrated direction switches.

Each function has a working angle of $\pm 18^\circ$.

Signal range	Neutral signal
25% – 75%	50%
of supply voltage	

Note: When moving the handle diagonally the maximum signal range is not available.

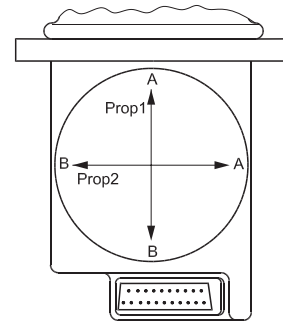

162B89.10

Connector

All joysticks come with a common **25 pin male SUB-D connector** with M3 screws. (MIL - DTL - 24308)

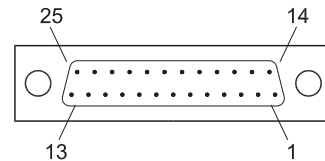

162B78.11

Direction Switches

Proportional modules have integrated direction switches. One switch is activated when the module is moved in the A direction, the other is activated when the module is moved in the B direction.

The direction switches are used to activate the neutral position switch, and with some electronic modules the direction switch outputs are available in the connector. (See details about electronics.)

There is a dead band in the joystick of approximately 1.5° before the direction switches are activated.

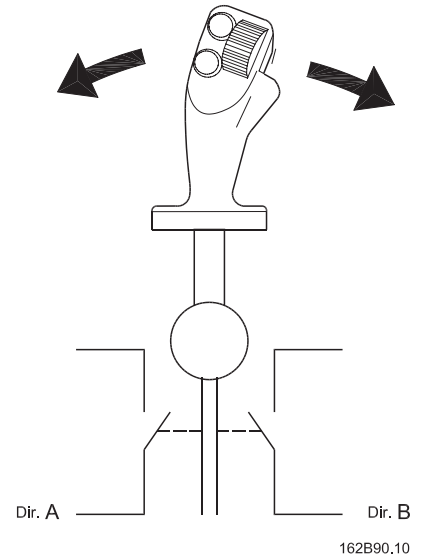

Note: The direction switches are independent from the signal voltage

162B90.10

Neutral Position Switch

The neutral position switch can supply up to 3 PVEs or other devices (see electrical details), and functions as both a power save and a safety switch.

The switch is only activated when one or more of the proportional modules are activated.

The operation of the neutral position switch is dependant on signals from the direction switches.

Sauer-Danfoss recommends that the neutral position switch be used to the greatest possible extent.

Note: When using the neutral position switch all three U_{DC} wires as well as all three Neutral Switch wires **must** be connected.

Cables

For compatibility with different applications, a selection of mating cables are available:

Code no. 162B....	Length mm [in]	Plug type	Type
6013	4000 [157]	Leads	Vertical SUB-D
6014	4000 [157]	Leads	Horizontal Sub-D
6015	500 [19]	Clipper	-
6016	230 [9]	TrimTrio	-
6017	230 [9]	Tabs	PVRE compatibility

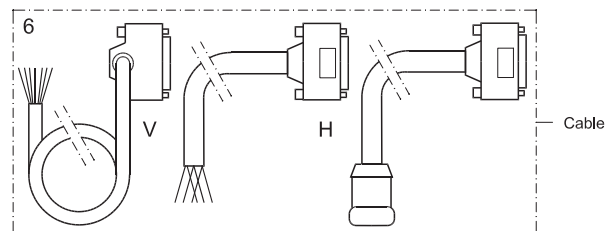





162B93.10 .10

PVRE Series 2

The PVRE series 2 is the successor to the popular PVRE joystick. This joystick builds on the known technology from the Prof family of joysticks as well as the well known handles from the PVRE series 1 joysticks.

Versions

The PVRE handle is available in three different variants: No top function, with prop 3, and with two On/Off functions (rocker switches).

Code no. 162F...	1310 (1300)	1311 (1301)	1312 (1302)	1313 (1303)	1314 (1304)
Symbol	 155B60.10	 155B62.10	 155B64.10	 155B63.10	 155B147.10
Prop1	X	X	X	X	X
Prop 2	X	X	-	-	X
Prop 3	-	-	-	-	X
On/Off	X	-	X	-	-

() Incl. PVRE series 1 adapter ring for mounting in place of a PVRE Series 1

Location and Orientation of Functions

It is possible to turn the PVRE handle through 180° to make the direction of movement fit the application.

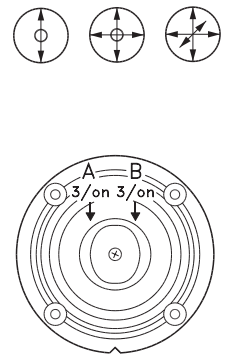
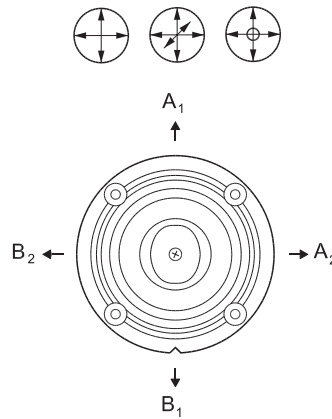
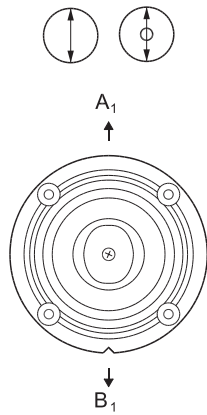
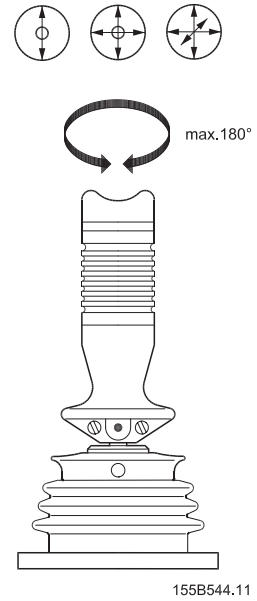

155B545.10

Connections

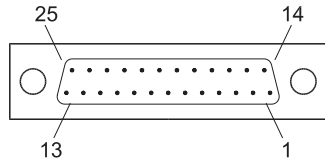

162B78.11

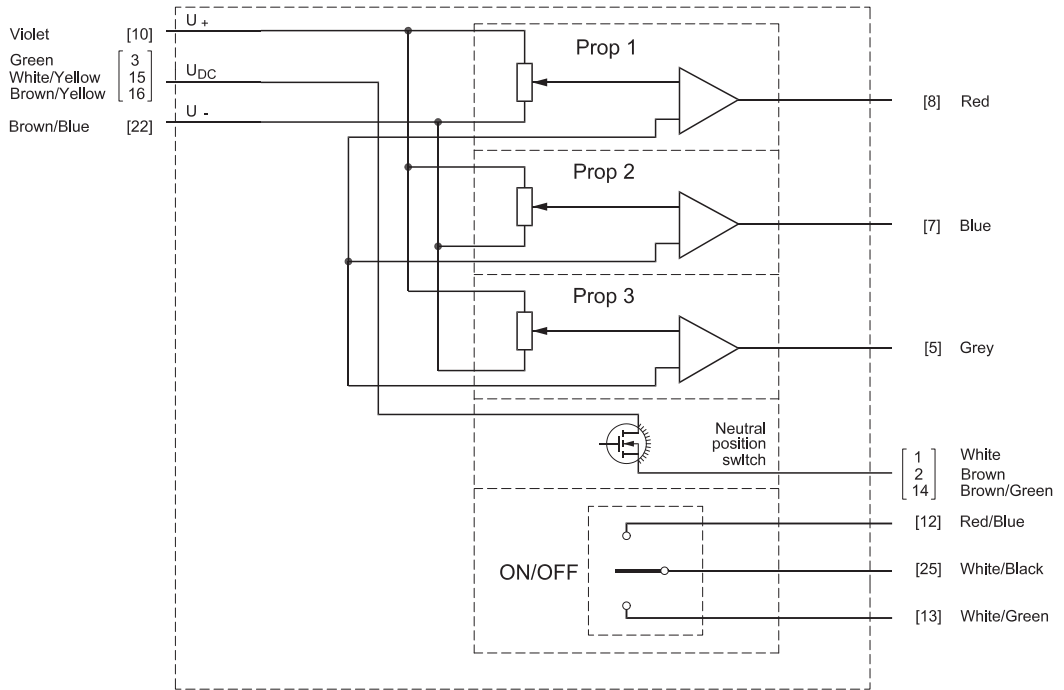

162B79.10

Numbers in [] indicate pin number in sub-D connector.

Technical Data

Enclosure	Below flange	IP 21	
	Above flange	IP 65	
	With On/Off	IP 42	
	With Prop 3	IP 65	
Ambient temperature	-30 - +60° [-22 - +140°F]		
Supply voltages	U_{DC}	10-30 V	
	Max ripple	5%	
Current consumption	≈150 mA		
Signal voltage	$\frac{U_s}{U_{DC}}$	Min → Max	0.25 → 0.75
		Neutral position	0.50
Signal load in neutral position	Load type	PVE	Other
	Load impedance	>6 kΩ	>15 kΩ
Signal current at max movement		$\frac{U_s - 0.5 \times U_{DC}}{6 \text{ k}\Omega}$	$\frac{U_s}{15 \text{ k}\Omega}$
	@ $U_{DC} = 12 \text{ V}$	±0.6 mA	0.2 → 0.6 mA
	@ $U_{DC} = 24 \text{ V}$	±1.2 mA	0.4 → 1.2 mA
Signal current in neutral position	@ $U_{DC} = 12 \text{ V}$	±0 mA	0.4 mA
	@ $U_{DC} = 24 \text{ V}$	±0 mA	0.8 mA
On/Off switch	Max load	0.6 A	
Neutral position switch	Max load	3 A	

Dimensions

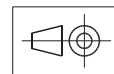
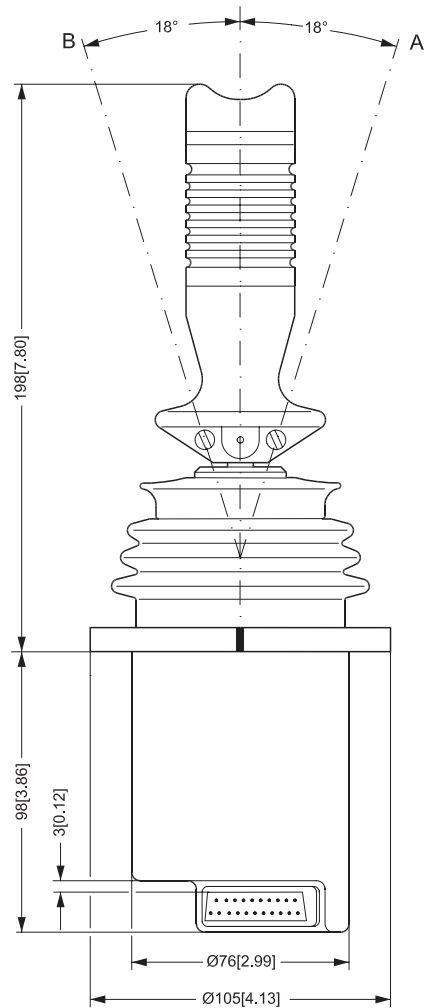
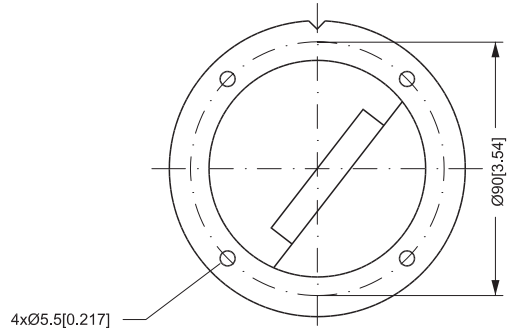

162B130.10

Examples of Use



155B60.10

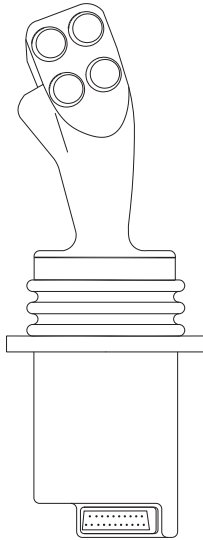

155B147.10

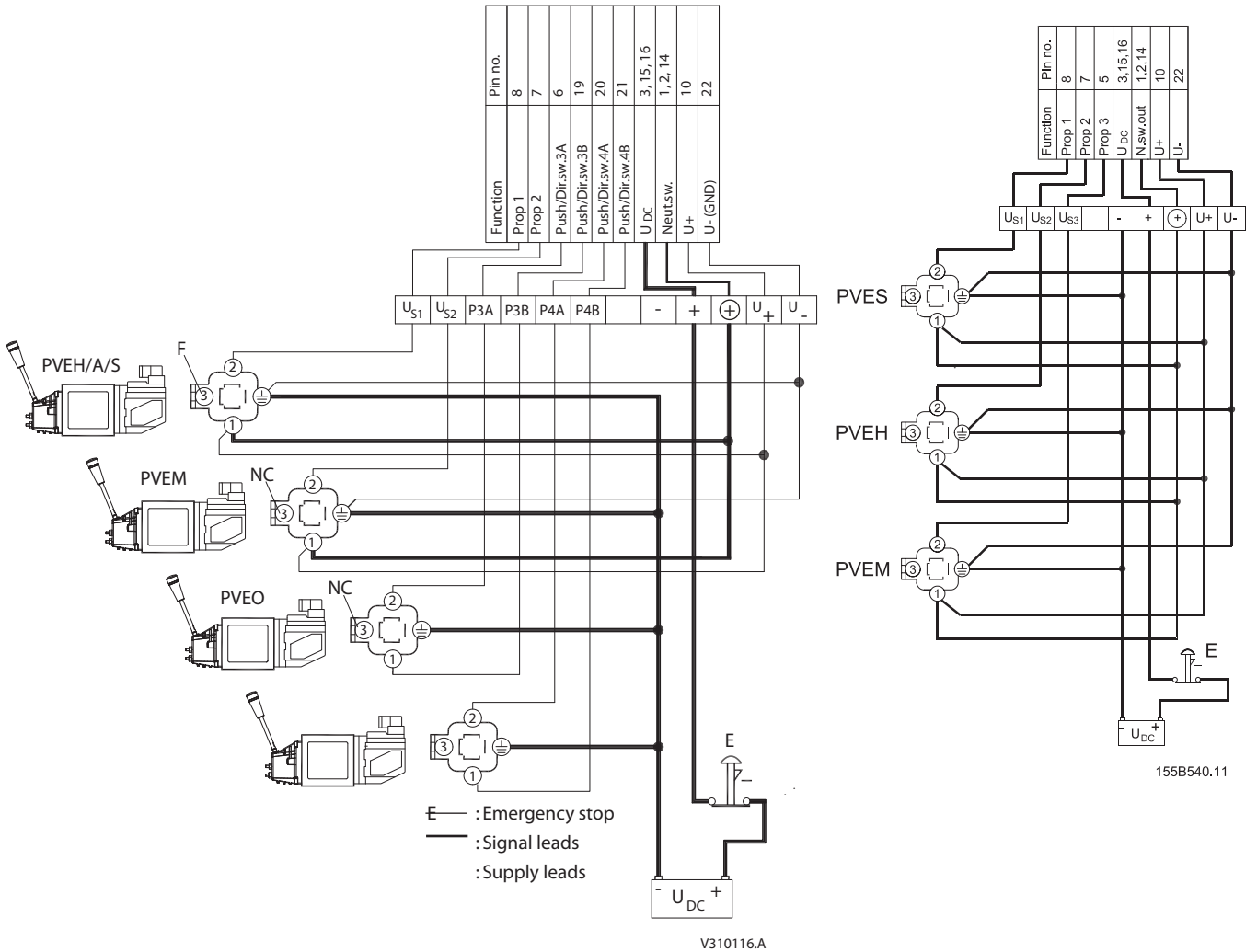
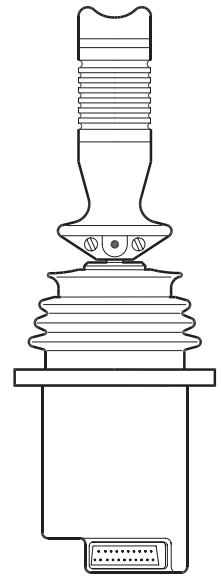

155B540.11