

Receiver
From

 Society
 Reference
 Address
 Phone
 Fax
 E-mail

Item n° :

60121345

Model :

AQUAJET 82 M-G

Pump data

 Pressure rating : 8 bar (800 kPa)
 Min. fluid temperature : 0 °C
 Max. fluid temperature : 35 °C
 Max. Ambient temperature : 40 °C

Priming capacity :

H	m	2	3	4	5	6	7	8	9
Q	m³/h	3.06	2.76	2.46	2.28	1.92	1.74	1.32	1.02

Requested data

 Flow : 0.00 m³/h
 Head : 0.00 m
 Fluid : Water, pure
 Fluid Temperature : 20 °C
 Density : 998.3 kg/m³
 Kinematic viscosity : 1.005 mm²/s
 Vapor pressure : 100.00 kPa

Hydraulic data (duty point)

 Flow :
 Head :

Materials

 Pump body : Cast iron 200 UNI ISO 185
 Support : Die cast aluminium
 Impeller : Technopolymer A
 Mechanical seal : Carbon/Ceramic
 OR ring : NBR Rubber
 Shaft with rotor : AISI 416 X12 CrS 13 UNI 6900/71
 Nozzle venturi dif fuser assembly : Technopolymer A

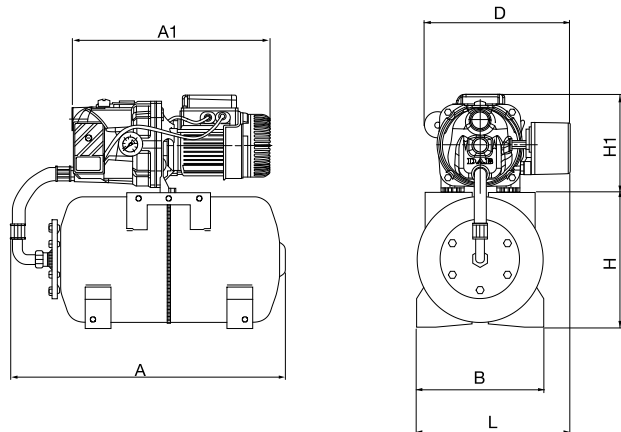
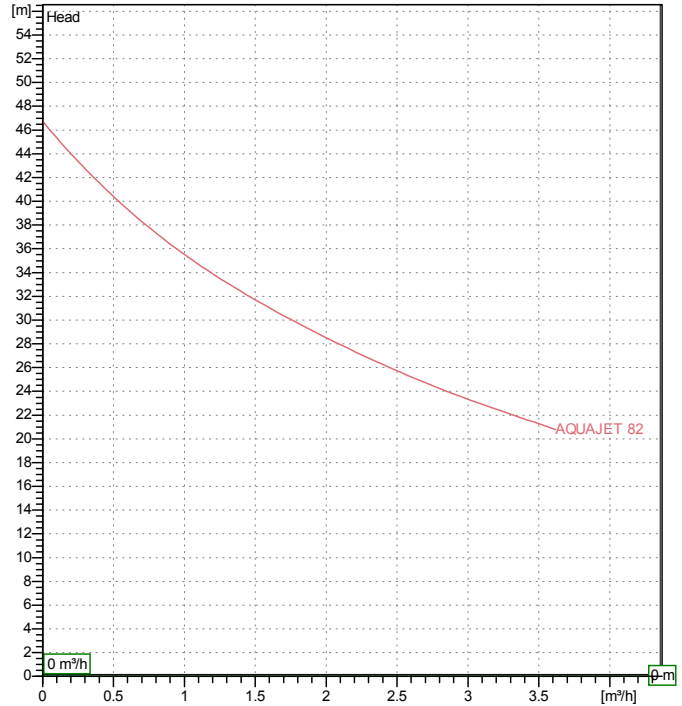
Curve tolerance according to ISO 9906

Motor data

 Motor brand : DAB
 Nominal power P2 : 0.6 kW
 Rated speed : 2750 rpm
 Rated voltage : 1~ 220-240 V
 Nominal current : 3.8 A
 Degree of protection : IP 44

50 Hz

Dimensions in
mm

A	492	DNA	1"G	L	301		
A1	393	DNM	1"G				
B	263	H	296				
D	256	H1	194				

Weight : 17.8 kg

Pump connection

 Suction side : 1 " G / 8 bar (800 kPa)
 Discharge side : 1 " G / 8 bar (800 kPa)



PERFORMANCE CURVES

24/03/2016

Page 2 / 3

Receiver

From

Society
Reference
Address
Phone
Fax
E-mail

AQUAJET 82 M-G

Curve tolerance according to ISO 9906

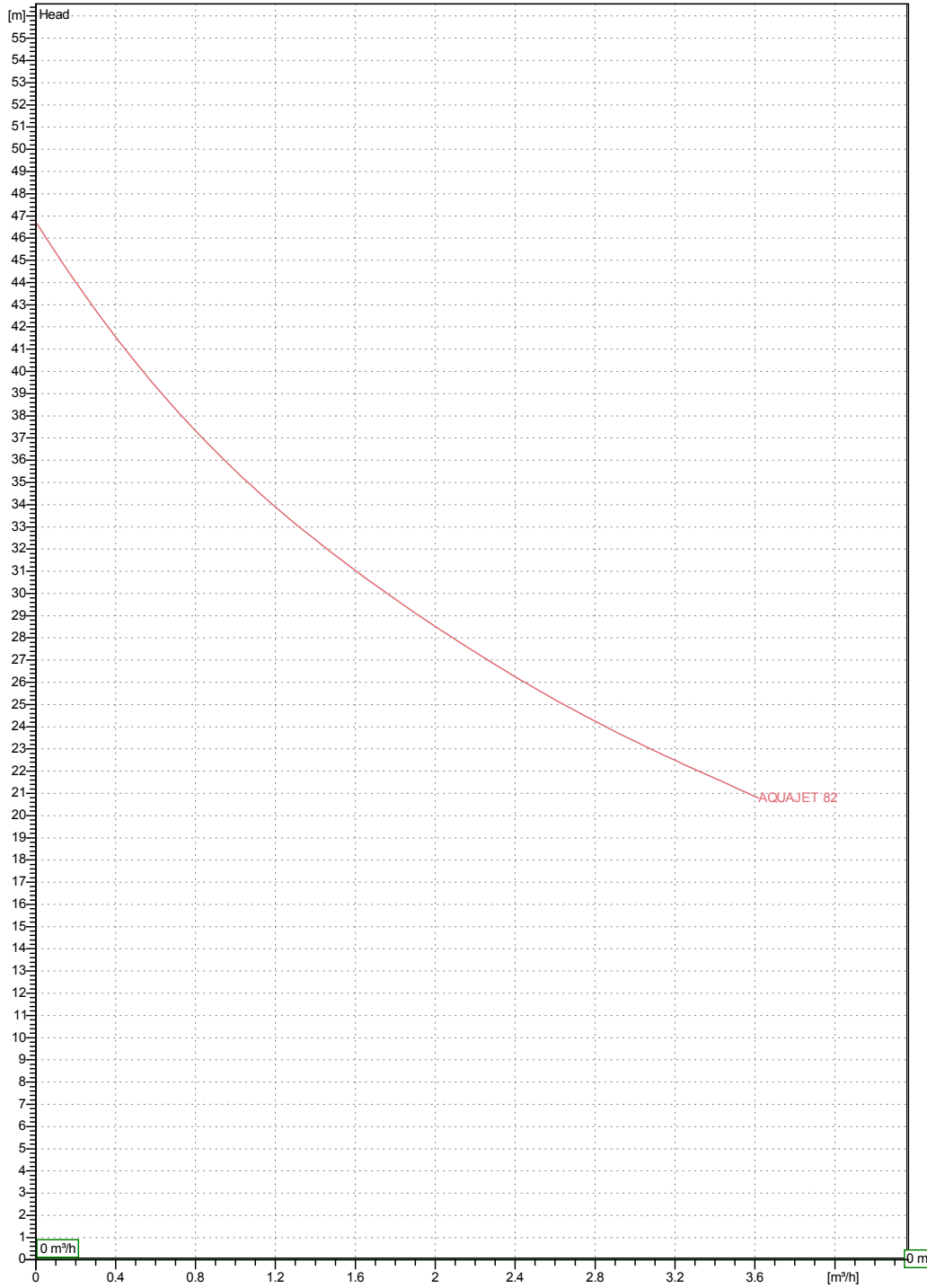

Hydraulic data (duty point)

Suction side : 1 " G 8 bar (800 kPa)	Discharge side : 1 " G 8 bar (800 kPa)	Flow : 0 m³/h	Head : 0 m	Rated speed : 2750 rpm
Project	Project ID	Created by	Created on 24/03/2016	

Receiver

From

Society
Reference
Address
Phone
Fax
E-mail

AQUAJET 82 M-G

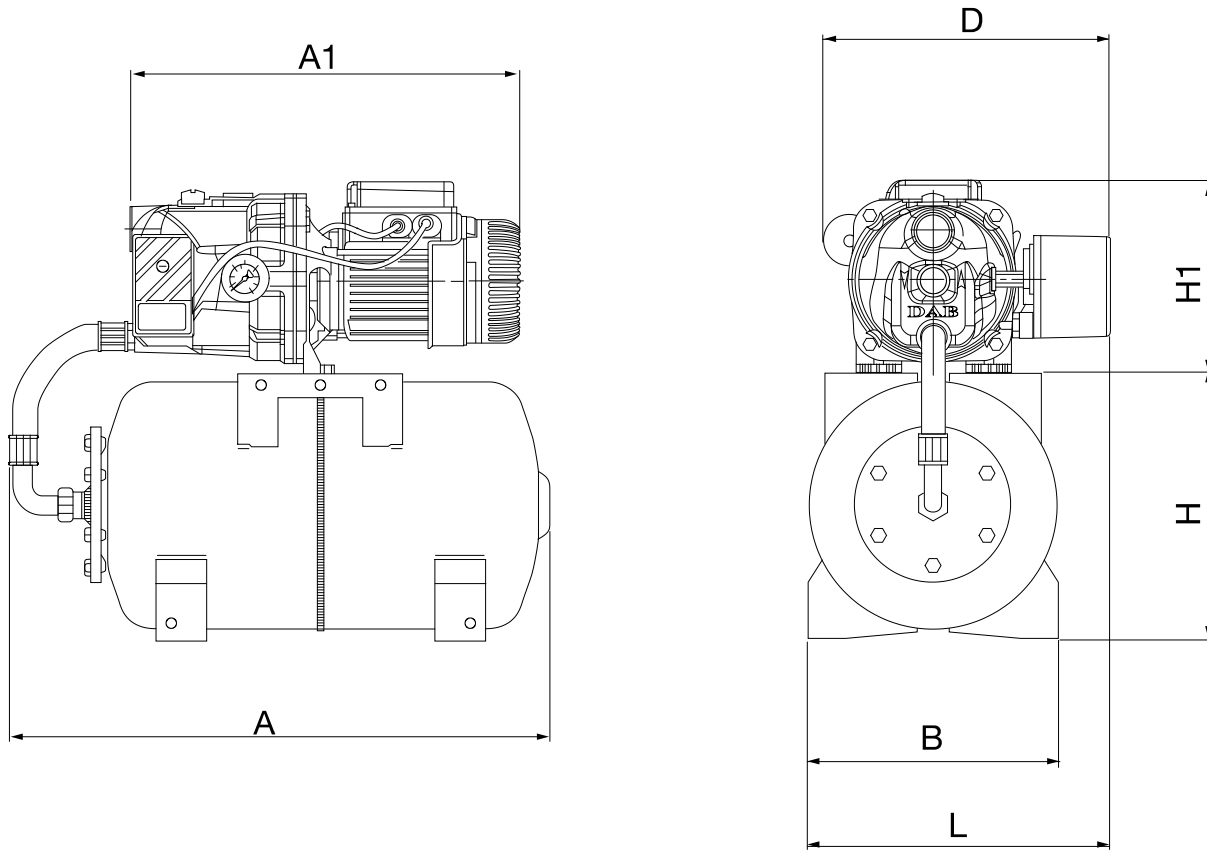

Dimensions in mm

1	A	492				
2	A1	393				
3	B	263				
4	D	256				
5	DNA	1"G				
6	DNM	1"G				
7	H	296				
8	H1	194				
9	L	301				

Pump connection

Suction
1 " G
8 bar (800 kPa)

Discharge
1 " G
8 bar (800 kPa)

Project

Project ID

Created by

Created on

24/03/2016